

Panneau Triptyque

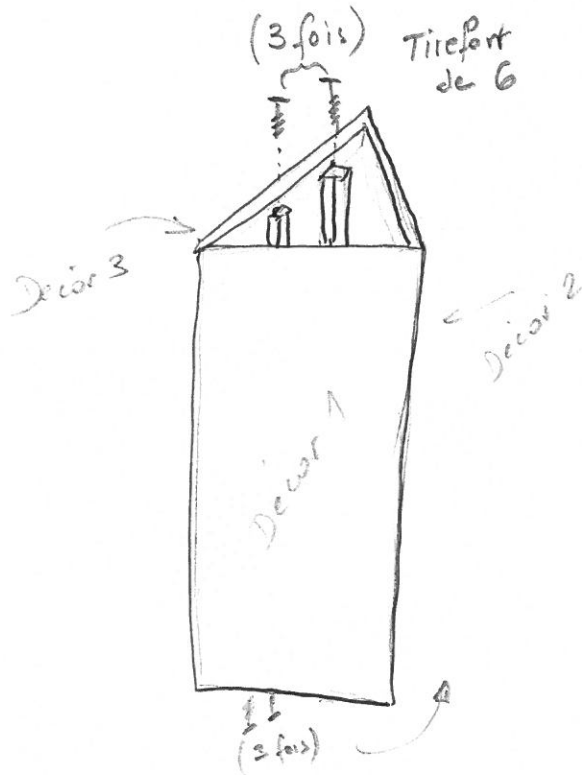

Panneau de contreplaqué
5 mm
3 x (2,44 x 1,22) (Brico dépôt)

Section bois
1/2 chevron

Cadre du fond et de dessus

Coef 2

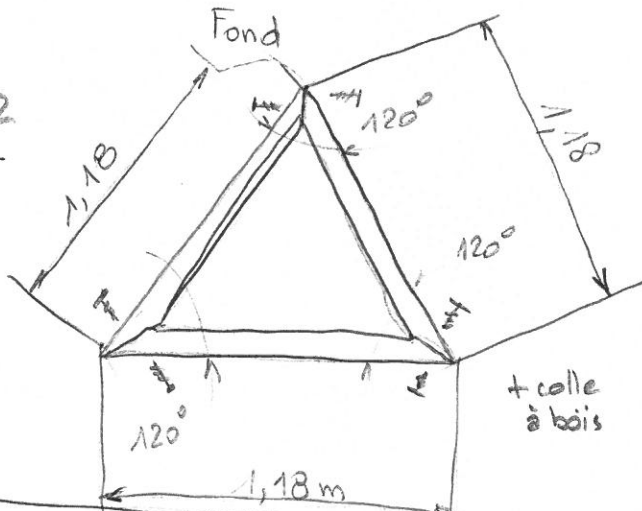

Panneau renforcé

Coef 3

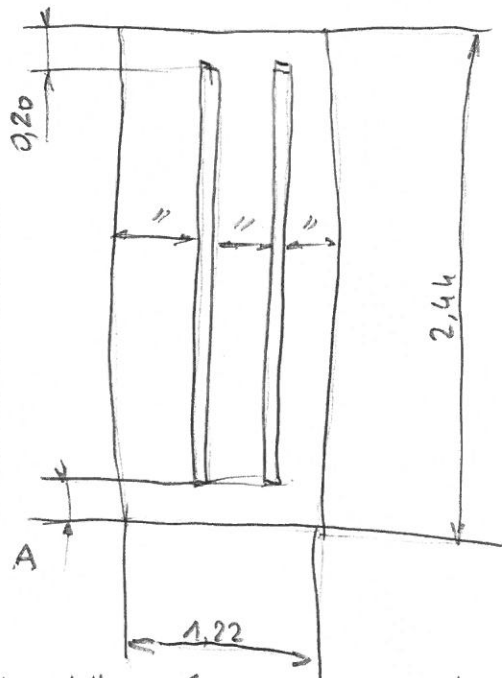

A = Hauteur de roulette + épaisseur cadre inférieur - 3 mm
+ épaisseur support roulette

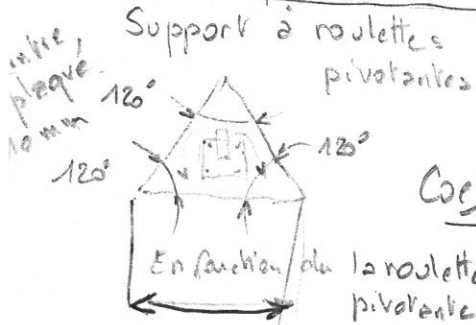
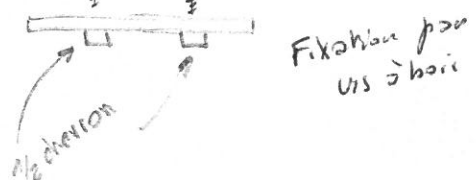

Coef 3

Variante pour les panneaux

Passer de 3 décors à 6 décors sur le m^e support

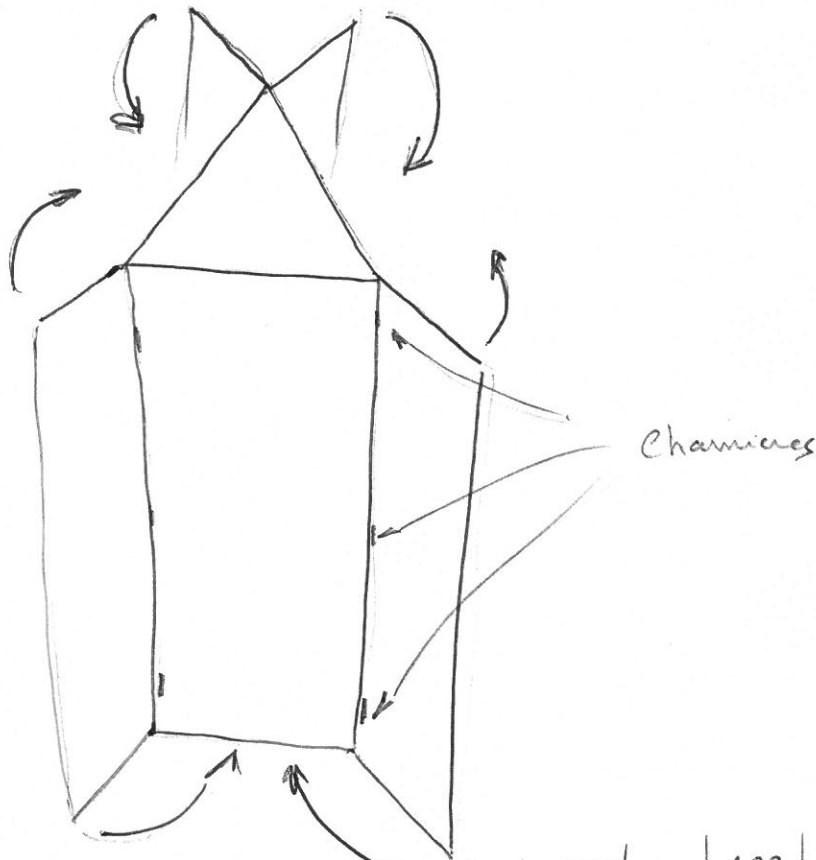

(A) soit 6 décors de 1,22 de large

(B) soit 3 décors de 2,44 de large

Versia

(A)

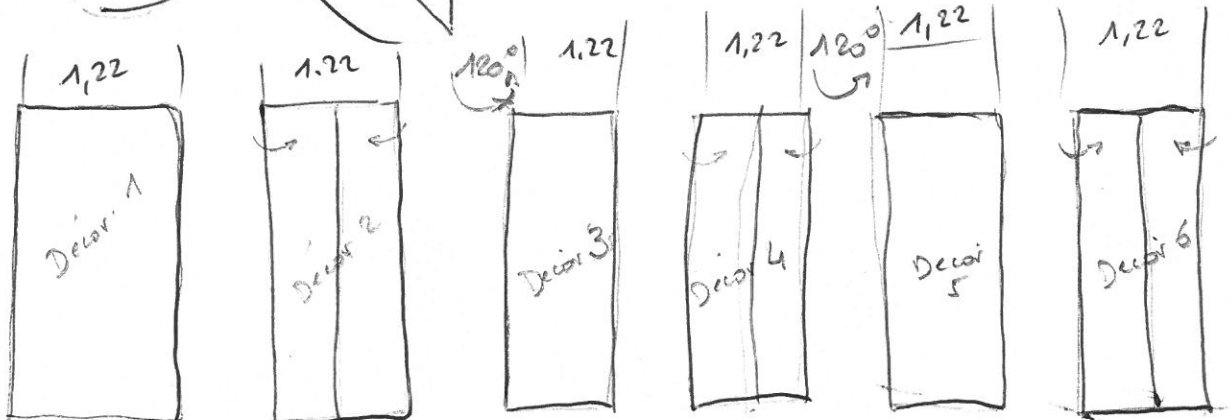

Versia

(B)

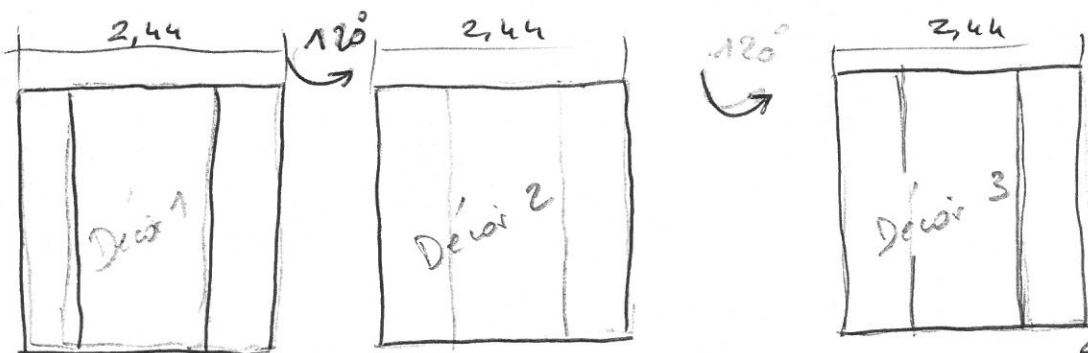

SYMPHONIA pour Margot GRELLIER
Comédia dell'ESSEC

2017.01

Bar simplifié

